

Scan and Login website  
for more information



Management  
System  
EN ISO  
13485:2016  
www.tuv.com  
DE 200000214

# Ultrasonography Tip Book



## Osteotomy

Model

Unit: mm

Page

SS1

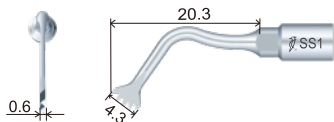

1

SS1L

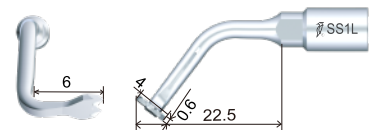

2

SS1R

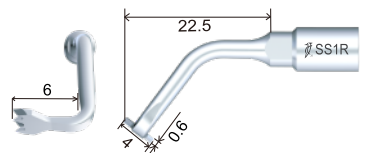

2

SS2

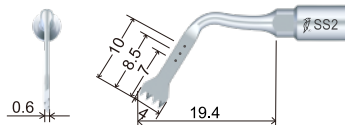

3

SS3

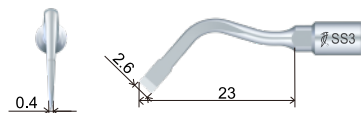

3

## Osteotomy

Model

Unit: mm

Page

SS4

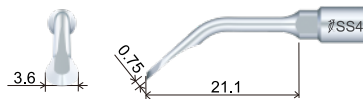

4

SS5

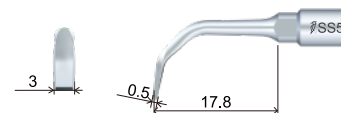

4

SS6

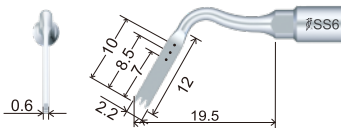

5

SS8

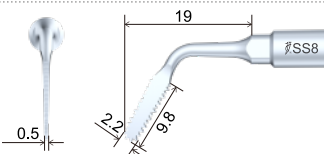

5

SS9

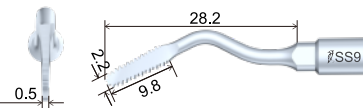

6

**Osteotomy**  
Model

Unit: mm  
Page

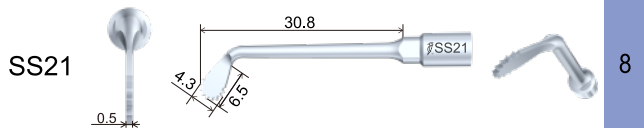
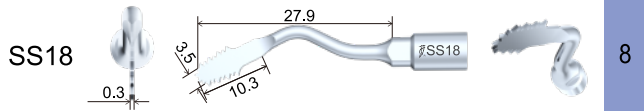
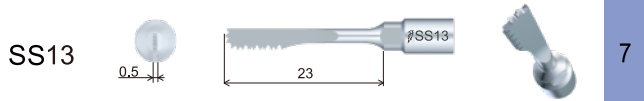
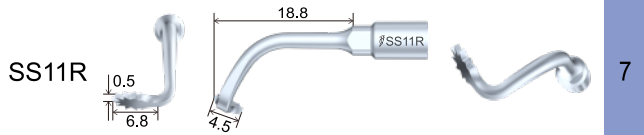
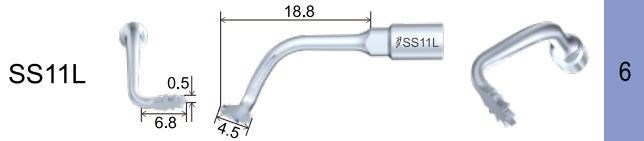

**Osteotomy**  
Model

Unit: mm  
Page

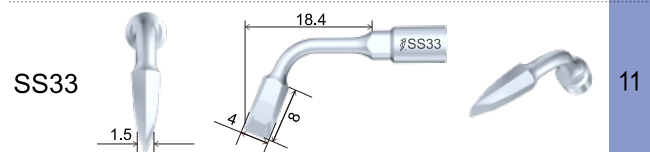
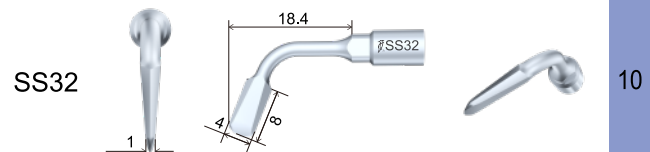
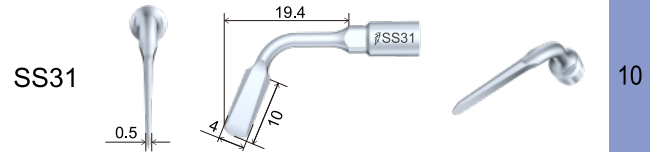
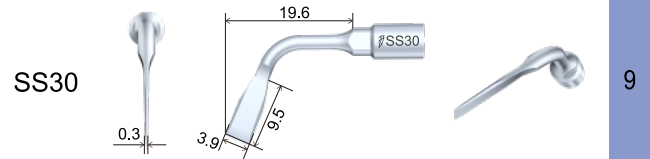
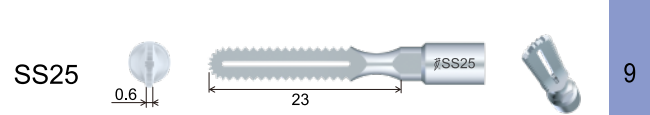

## Osteotomy

Model

Unit: mm  
Page

SS34

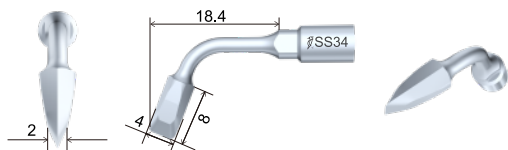

11

## Sinus lifting

Model

Unit: mm  
Page

SL1

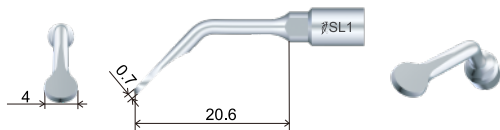

12

SL2

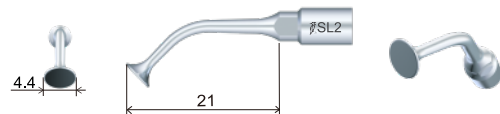

12

SL3

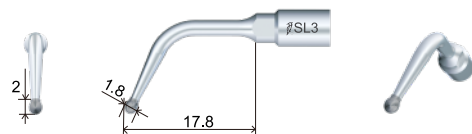

13

## Sinus lifting

Model

Unit: mm  
Page

SL4

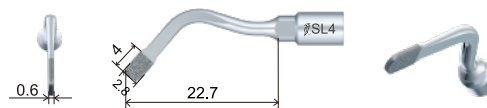

13

SL5

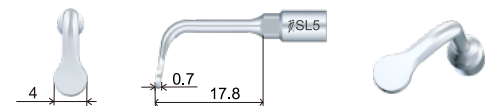

14

SL6

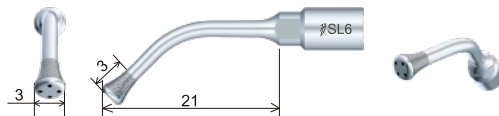

14

SL7

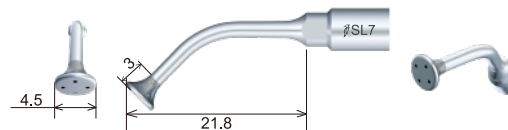

15

SL8

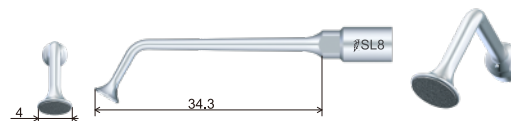

15

## Sinus lifting

Model

Unit: mm  
Page

SL13

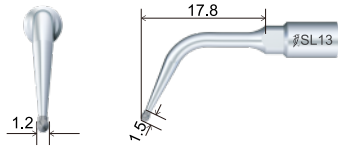

16

SL14

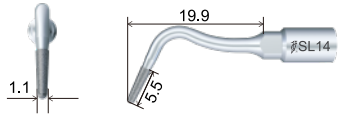

16

## Endodontics Unit

Model

Unit: mm  
Page

SE1

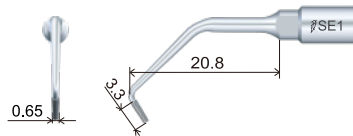

17

SE2

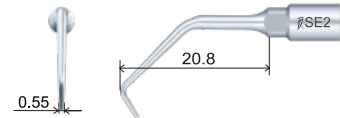

17

## Endodontics Unit

Model

Unit: mm  
Page

SE3

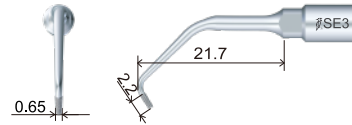

18

SE4

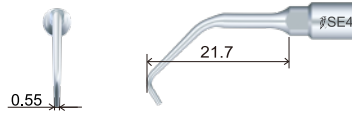

18

SE5

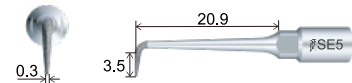

19

SE6

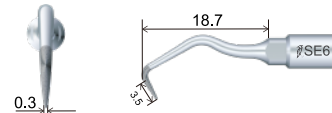

19

SE7

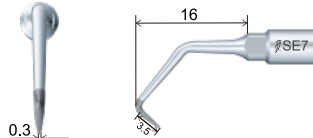

20

## Endodontics Unit

Model

Unit: mm  
Page

SE8

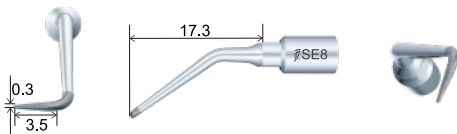

20

SE9

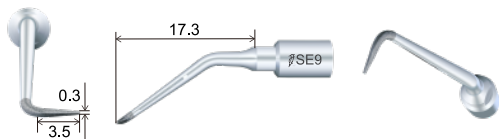

21

## Extraction

Model

Unit: mm  
Page

SC1

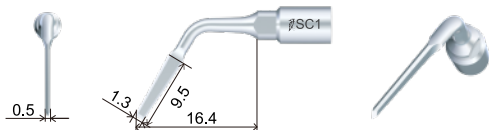

21

SC2

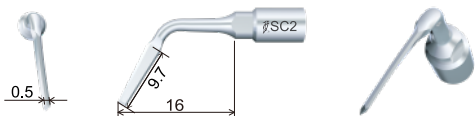

22

## Extraction

Model

Unit: mm  
Page

SC3

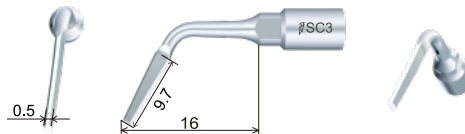

22

SC4

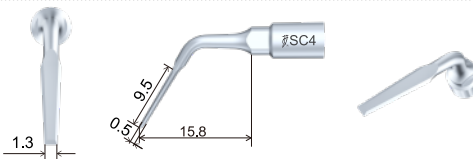

23

SC5

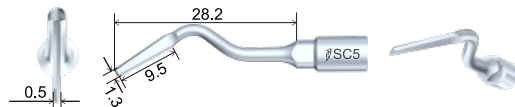

23

SC6

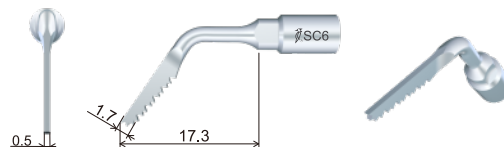

24

SC7

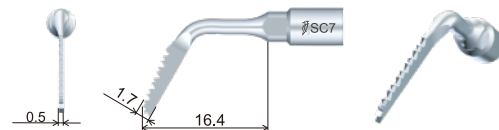

24

## Extraction

Model

Unit: mm

Page

SC8

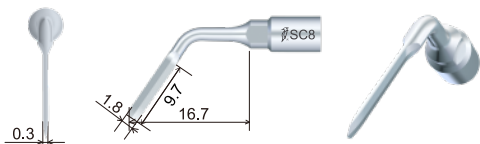

25

## Implantation

Model

Unit: mm

Page

SI1

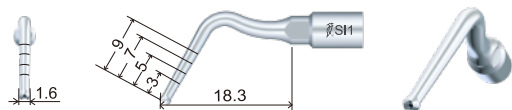

25

SI2

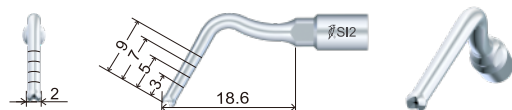

26

SI3

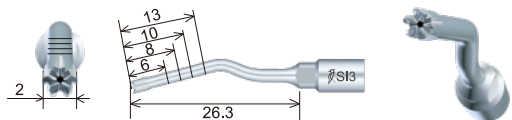

26

## Implantation

Model

Unit: mm

Page

SI4

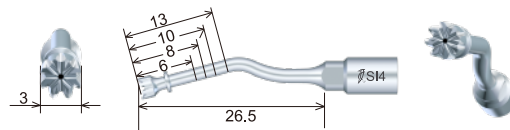

27

SI5

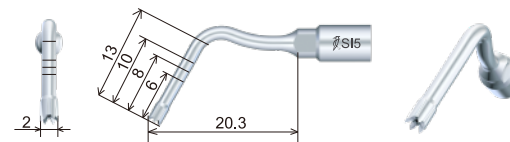

27

SI6

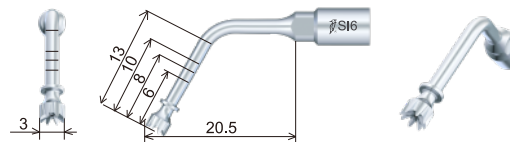

28

SI7

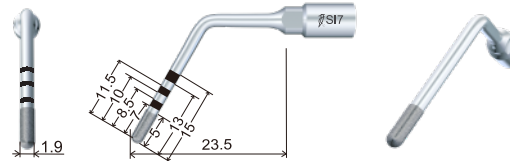

28

SI8

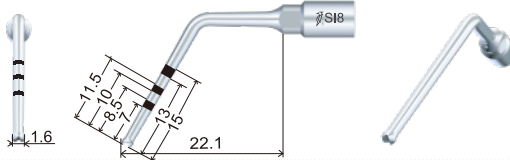

29

## Implantation

Model

Unit: mm

Page

SI9

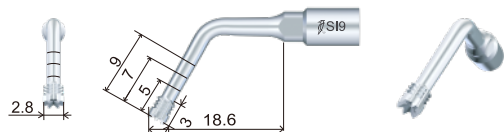

29

## Periodontal surgery

Model

Unit: mm

Page

SP1

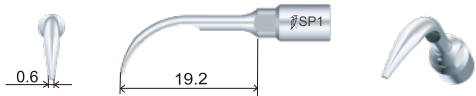

30

SP2

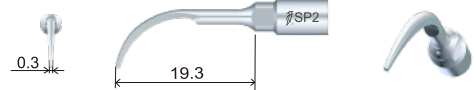

30

SP3

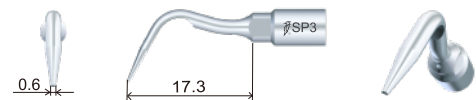

31

## Periodontal surgery

Model

Unit: mm

Page

SP4

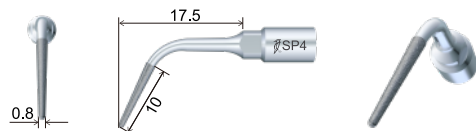

31

SP5

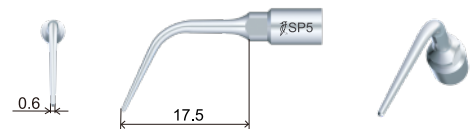

32

SP6

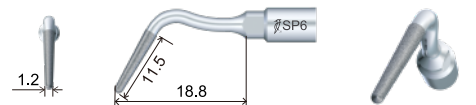

32

SP7

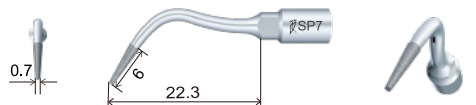

33

SP8

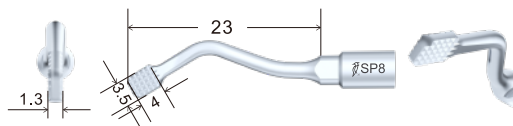

33



**Periodontal surgery**

Model

Unit: mm

Page

SP9

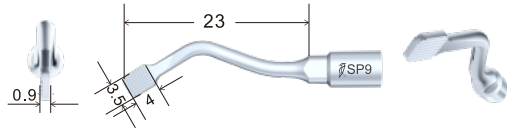

34

**SPOILING YOU  
SO MUCH!**



# Ultrasonography Tips

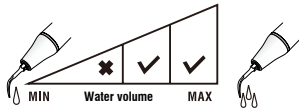

## Water volume:

The first grid indicates the water volume: 0-30%

The second grid indicates the water volume: 30%-60%

The third grid indicates the water volume: 60%-100%

## SS1

Efficient osteotomy for larger bone sections in maxillofacial surgery and also for incisional extraction of wisdom teeth.

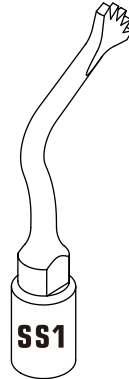

## Model: Bone

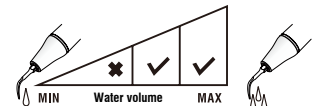
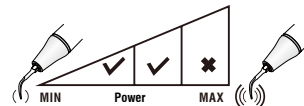

# SS1L

Left angle 90°, osteotomy on the maxilla and mandible.

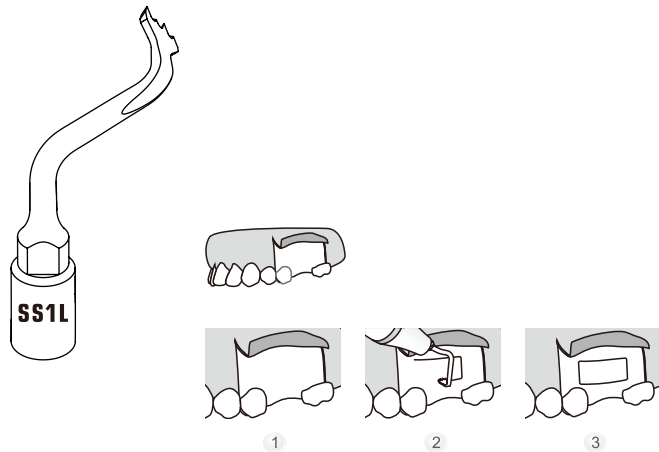

# SS1R

Right angle 90°, osteotomy on the maxilla and mandible.

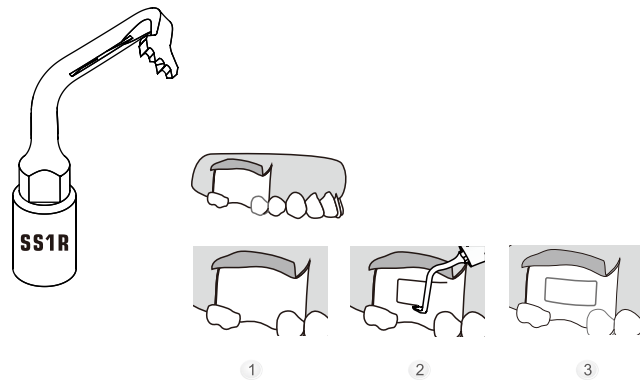

## Model: Bone

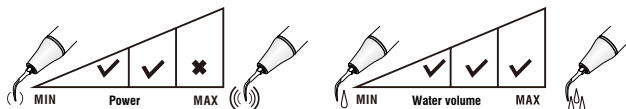

## Model: Bone

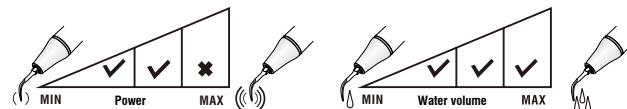

# SS2

High-effectiveness osteotomy on the maxilla and mandible (ridge expansion, corticotomy, bone grafting).

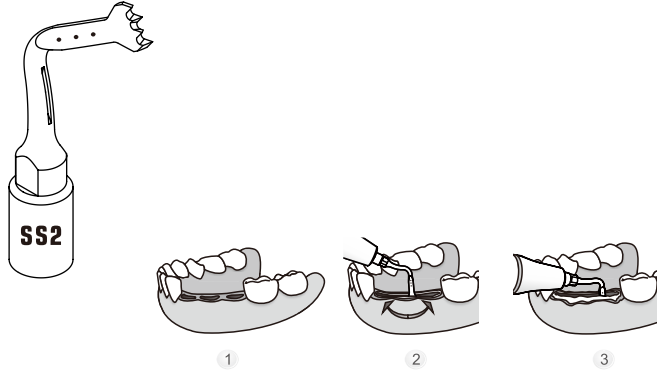

# SS3

Osteotomy: Osteotomy of high precision in anatomically thin structures.

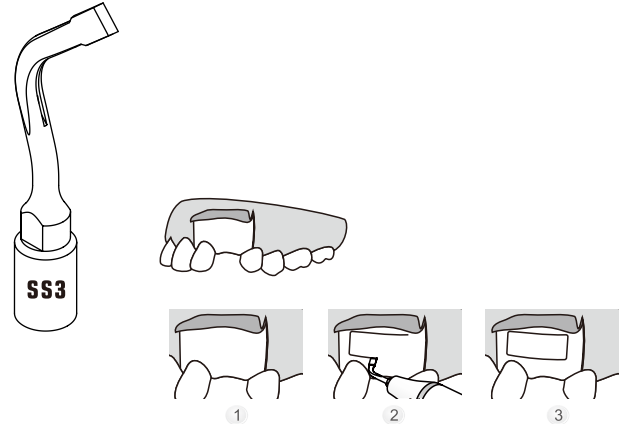

## Model: Bone



## Model: Bone



# SS4

Universal osteoplasty: periodontal osteotomy, harvesting of bone particles or chips, inflammatory tissue removal.

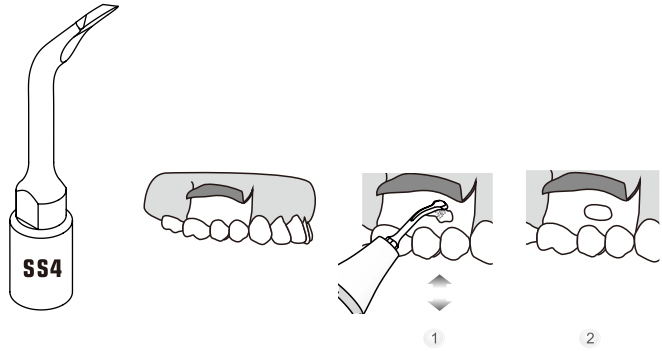

# SS5

High-efficiency osteoplasty: for bone remodeling or harvesting of bone particles or chips.

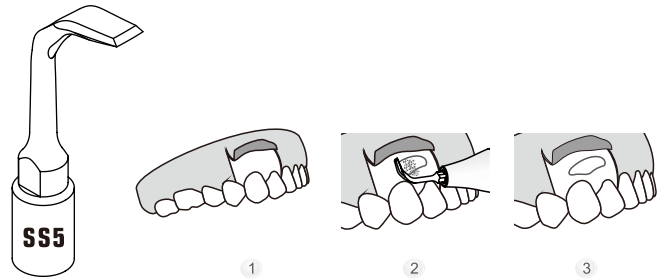

## Model: Bone



## Model: Bone

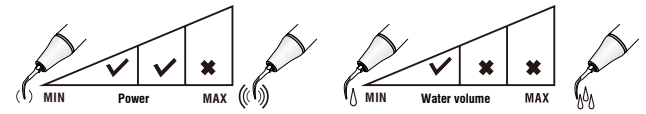

# SS6

Osteotomy: Osteotomy of high precision in anatomically thin structures (ridge expansion, corticotomy).

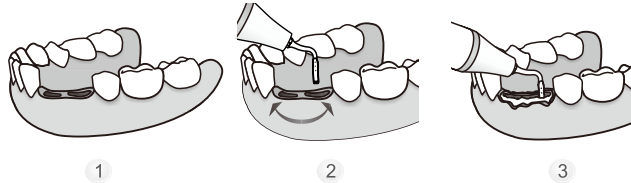
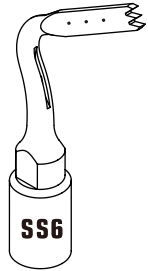

## Model: Bone

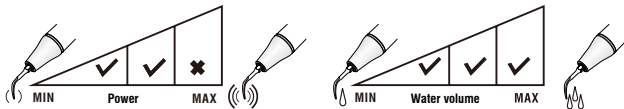

# SS8

Multi-faceted distribution of blade teeth, suitable for various osteotomies.

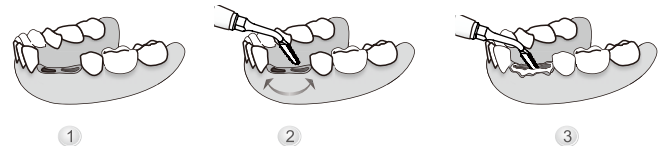
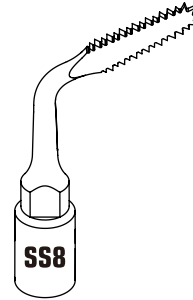

## Model: Bone



# SS9

Multi-faceted distribution of blade teeth, suitable for various osteotomies.

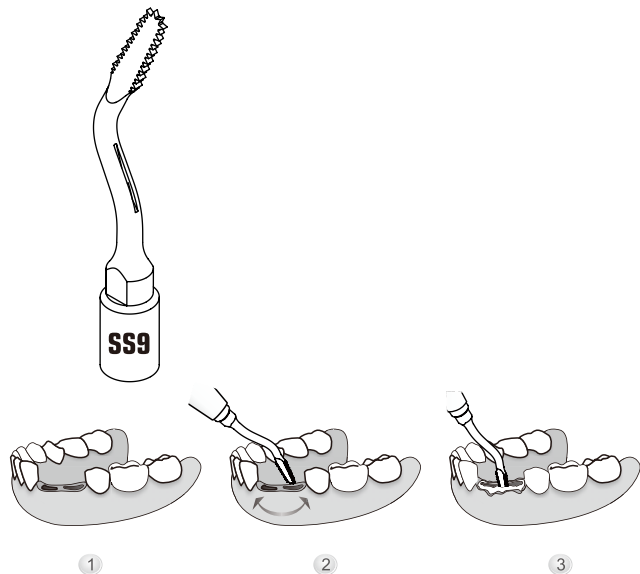

## Model: Bone



# SS11L

Left angle 90°, circumferential teeth, for osteotomy in special bone positions.

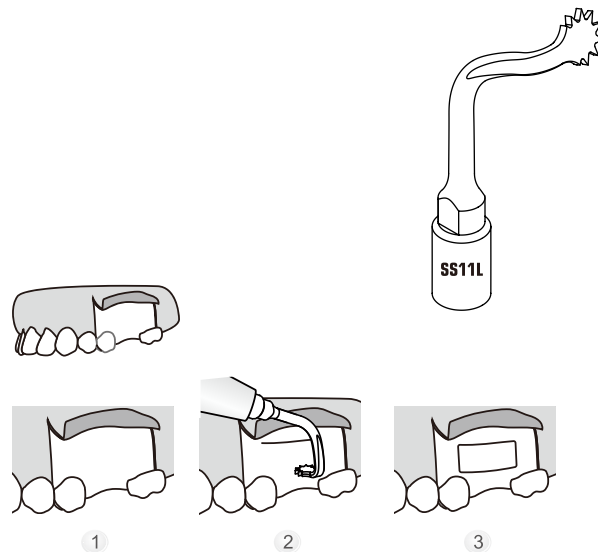

## Model: Bone

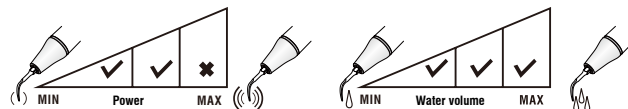



# SS11R

Right angle 90°, circumferential teeth, for osteotomy in special bone positions.

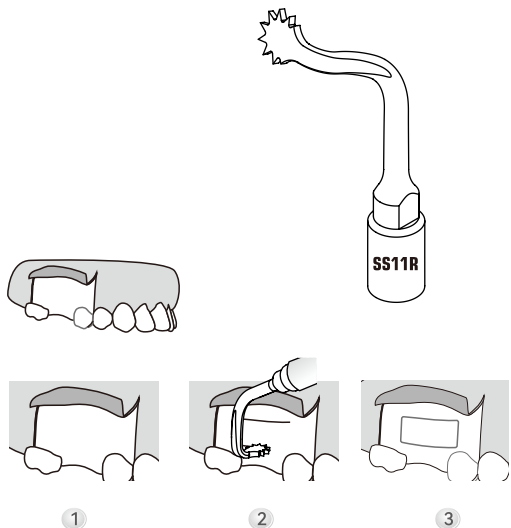

**Model: Bone**

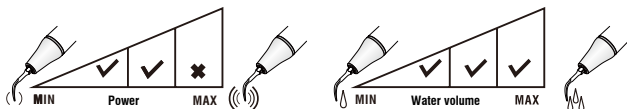

# SS13

For osteotomy and also for apex resection in the posterior tooth area in apical surgery.

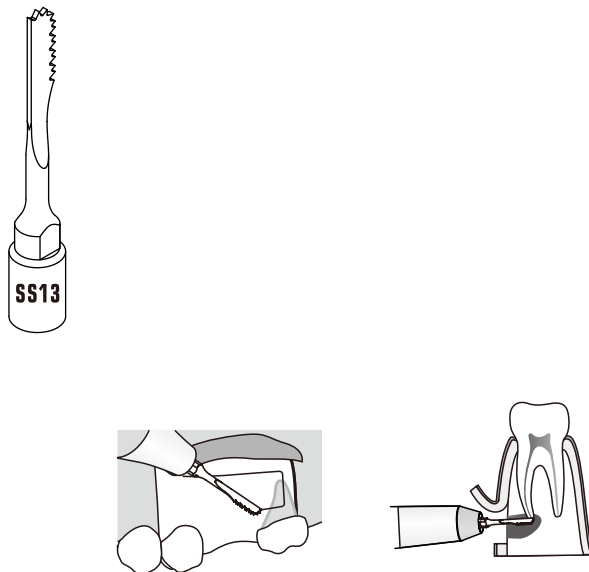

**Model: Bone**



# SS18

Extremely thin, for efficient osteotomy and also for apex resection.

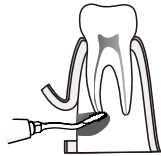
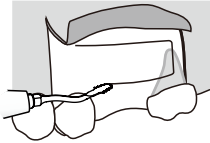

## Model: Bone

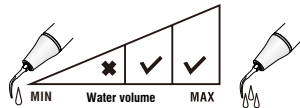
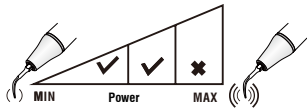

# SS21

For osteotomy. Fan-shaped serration, convenient for multi-angle cutting.

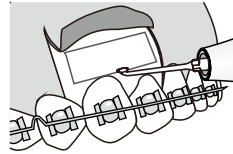
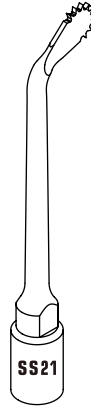

## Model: Bone

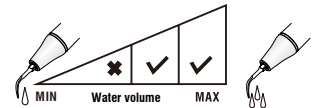
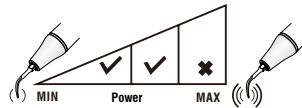

# SS25

For bone surgery.

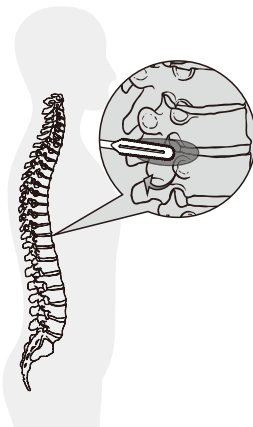

## Model: Bone

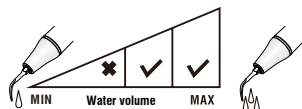
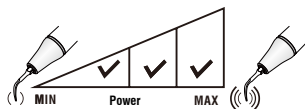

# SS30

Extremely thin, for cutting trajectory positioning and bone cutting in bone splitting technique.



## Model: Bone

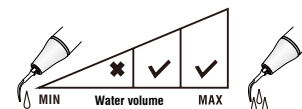
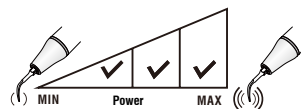

# SS31

Recutting on the bone cutting track in bone splitting technique, used after SS30.

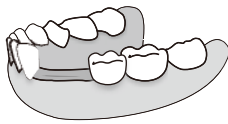
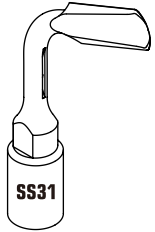

1



2

## Model: Bone

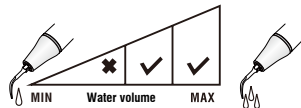
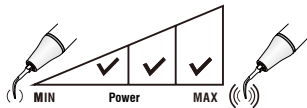

# SS32

For bone expansion in bone splitting technique. Conical sharp tip head, 1.8mm thickness at the front 8mm part.

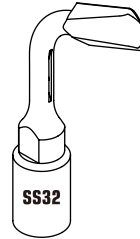

1



2

## Model: Bone

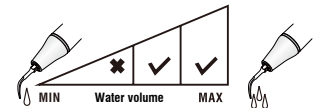
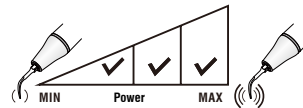

## SS33

For bone expansion in bone splitting technique. Conical sharp tip head, 2.75 thickness at the front 8mm part.

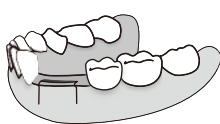
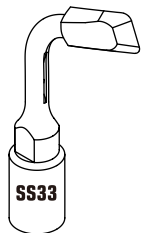

1



2

### Model: Bone

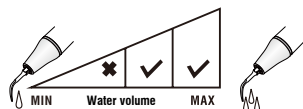
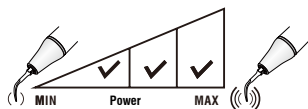

## SS34

For bone expansion in bone splitting technique. Conical sharp tip head, 3.75 thickness at the front 8mm part.

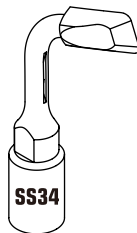

1



2

### Model: Bone

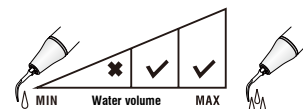
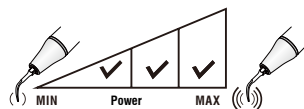

# SL1

Tip angle 120°. For maxillary sinus membrane detachment and elevation without damaging the maxillary sinus mucosa.

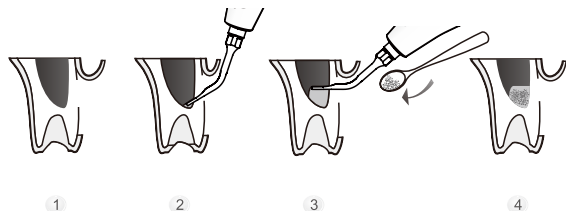
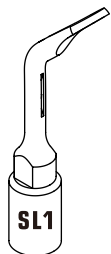

## Model: Perio

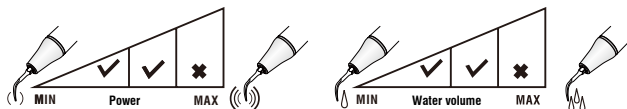

# SL2

For nasal mucosa separation: detachment of the maxillary sinus mucosa.

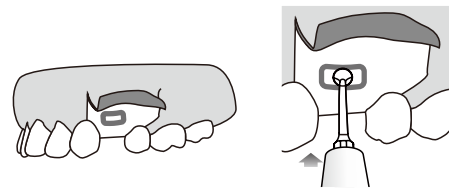
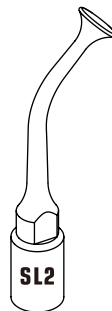

## Model: Perio



## SL3

Diamond-coated (100µm) tip for fine osteotomy or osteoplasty: for non-traumatic osteotomy close to soft tissue and sensitive areas.

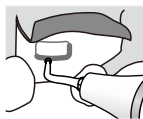
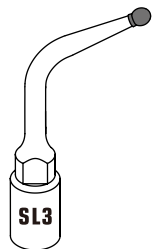

1

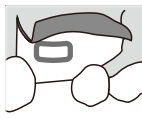

2

### Model: Bone

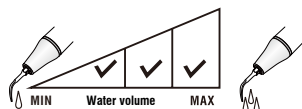
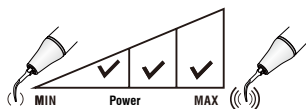

## SL4

Diamond-coated (100µm) tip for fine osteotomy: for cutting of extremely-thin bone, to avoid soft tissue damage (nasal mucosa, vessel, alveolar nerve).

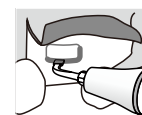
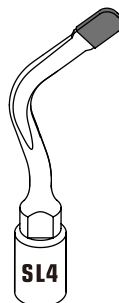

1



2

### Model: Bone

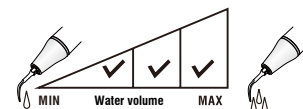
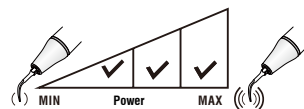

## SL5

Tip angle 95°. For maxillary sinus membrane detachment and elevation without damaging the maxillary sinus mucosa.

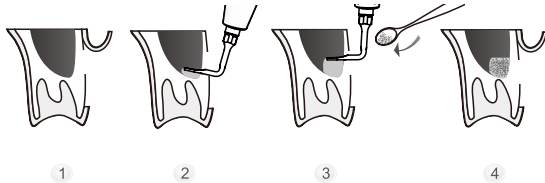
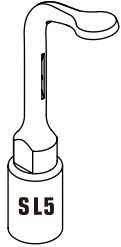

### Model: Perio

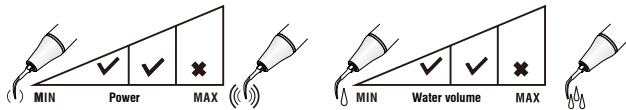

## SL6

Φ3mm head with four water outlets, for better separation of the maxillary sinus periosteum. The diamond-coated portion allows for trimming of the edges of the bone window.

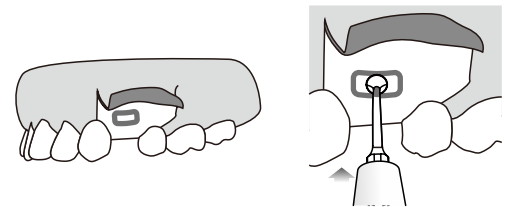
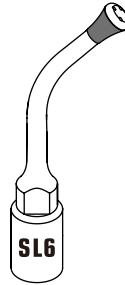

### Model: Perio

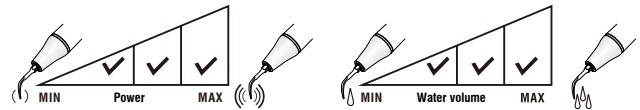



## SL7

Φ4.5mm head with four water outlets, for better separation of the maxillary sinus periosteum. The diamond-coated portion allows for trimming of the edges of the bone window.

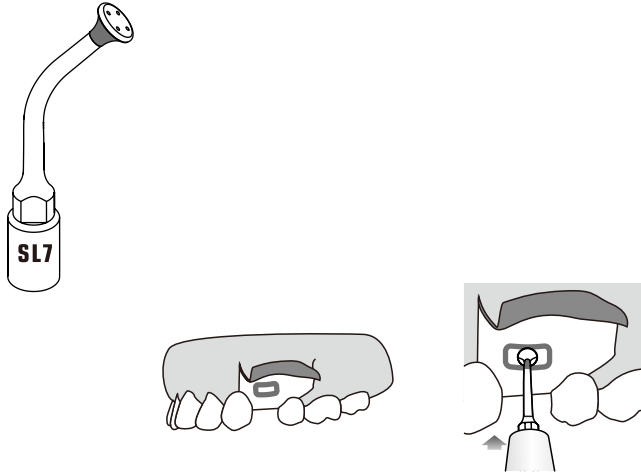

### Model: Perio

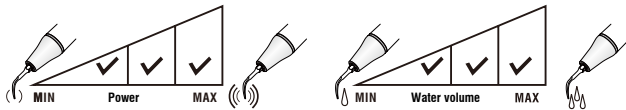

## SL8

Diamond-coated (100µm) tip for fine osteotomy or osteoplasty: for non-traumatic osteotomy close to soft tissue and sensitive areas.

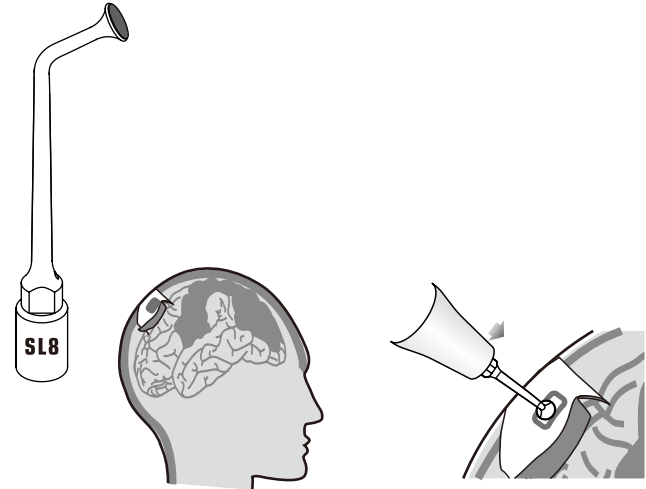

### Model: Perio

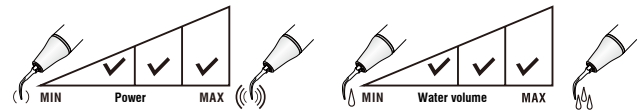

# SL13

Diamond-coated, for osteoplasty and bone trimming in the interproximal area, often used in crown lengthening.

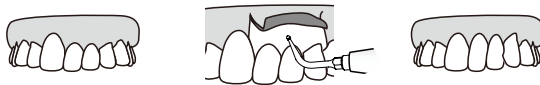
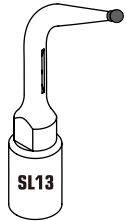

1

2

## Model: Bone

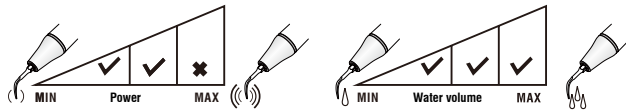

# SL14

Diamond-coated, for osteoplasty and bone trimming in the interproximal area, often used in crown lengthening.

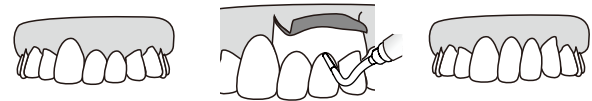
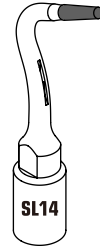

1

2

## Model: Bone



# SE1

Diamond-coated (40µm) tip for apical debridement: for high-efficiency root-end preparation and apical surgery. Diamond-coated part is 3.3mm in length.

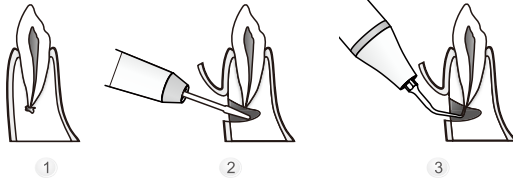
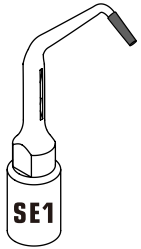

# SE2

Polishing the canal wall in apical debridement. The tip smooth part is 4.5 mm in length.

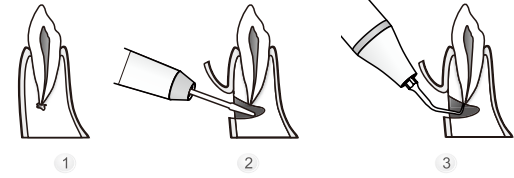
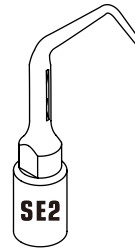

## Model: Endo

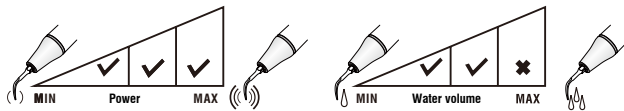

## Model: Endo

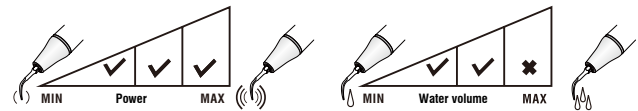

## SE3

Diamond-coated (40µm) tip for apical debridement: for high-efficiency root-end preparation and apical surgery. Diamond-coated part is 2.2mm in length.

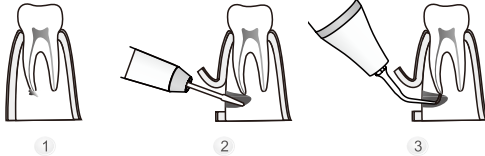
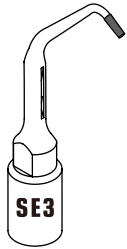

Model: Endo

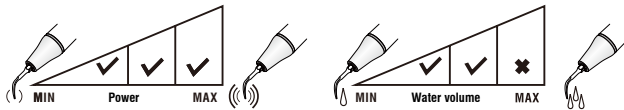

## SE4

Polishing the canal wall in apical debridement. The tip smooth part is 3.5 mm in length.

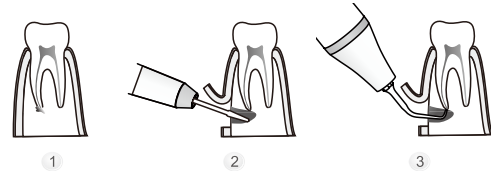
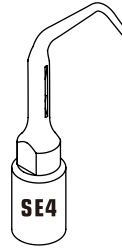

Model: Endo



# SE5

Diamond-coated, for root-end preparation.

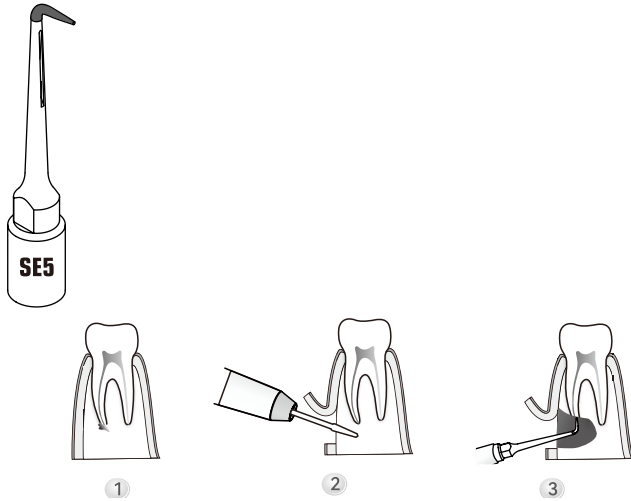

# SE6

Diamond-coated, for root-end preparation.

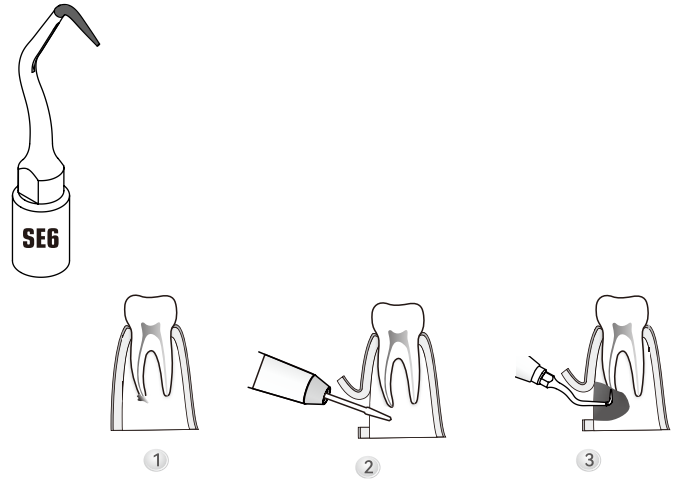

## Model: Endo

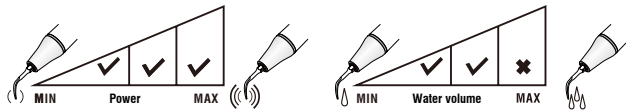

## Model: Endo

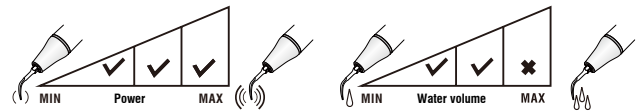

# SE7

Diamond-coated, for root-end preparation.



1



2



3

# SE8

Diamond-coated, for root-end preparation.

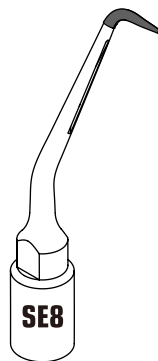

1



2

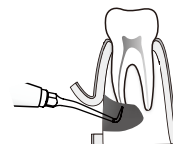

3

## Model: Endo

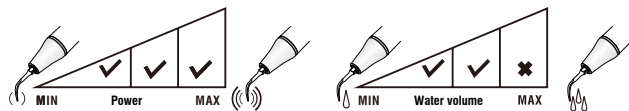

## Model: Endo

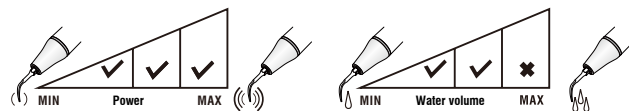

# SE9

Right-angled and diamond-coated tip, for root-end preparation.

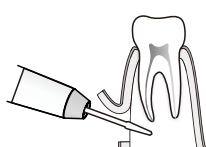
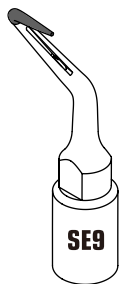

# SC1

For minimally invasive removal of ligaments and root surgery.

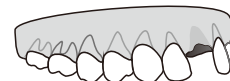
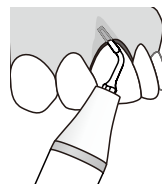
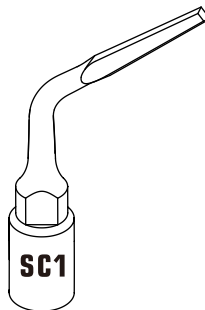

## Model: Endo

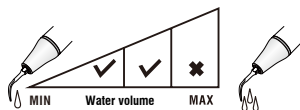
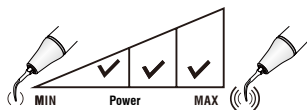

## Model: Bone

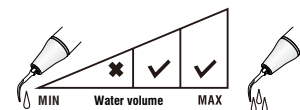
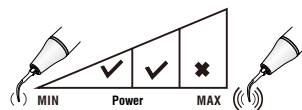

## SC2

Left-curved, for minimally invasive removal of ligaments and root surgery in posterior regions.

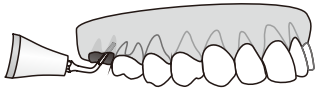

### Model: Bone



## SC3

Right-curved, for minimally invasive removal of ligaments and root surgery in posterior regions.

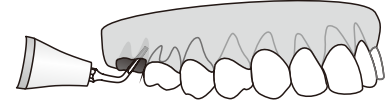
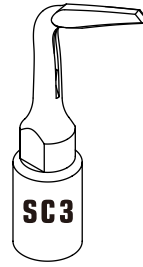

### Model: Bone





# SC4

For distal ligament cutting, minimally invasive extraction.

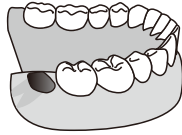
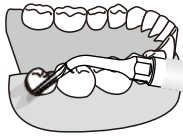

## Model: Bone

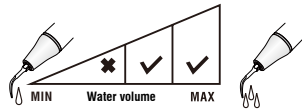
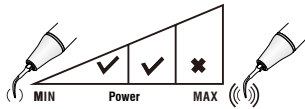

# SC5

For minimally invasive cutting of ligaments and gap increase in tooth extraction, especially suitable for the extraction of wisdom teeth with an oblique angle.

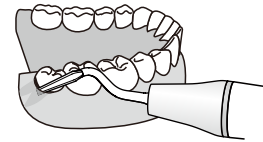

## Model: Bone

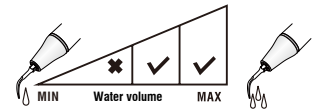
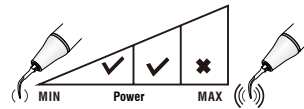

# SC6

For tooth extraction and alveolar bone splitting.

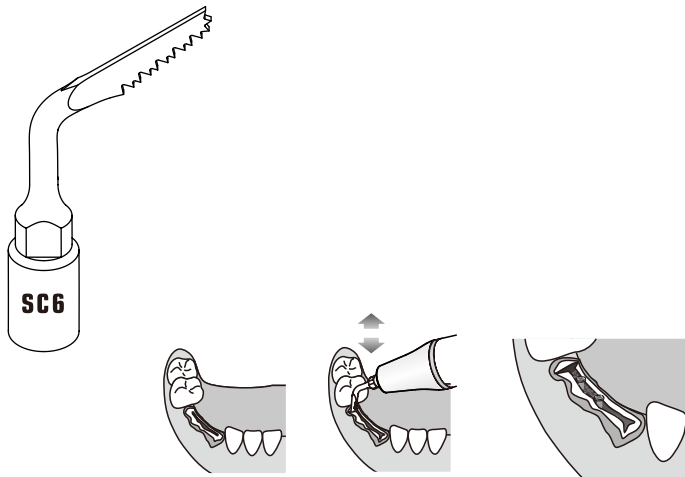

# SC7

For tooth extraction and alveolar bone splitting.

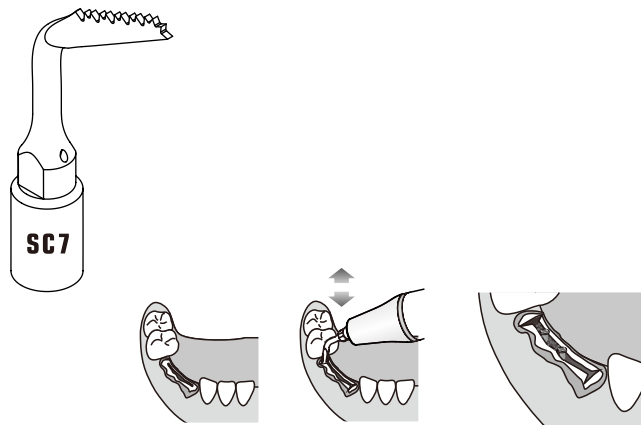

## Model: Bone



## Model: Bone



# SC8

For minimally invasive cutting of ligaments and gap increase in tooth extraction, with a very sharp and pointed tip extremity.

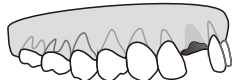
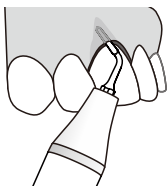
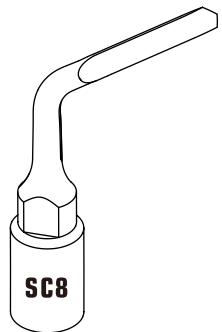

# SI1

For implant preparation, with  $\Phi 1.6\text{mm}$  head and 9mm tip working length.

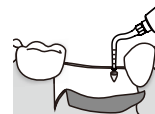
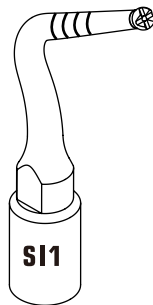

1



2



3

## Model: Bone

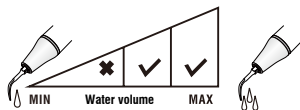
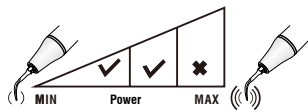

## Model: Bone

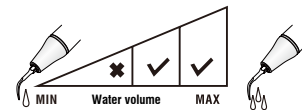
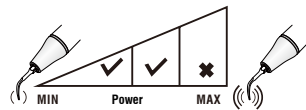

# SI2

For implant preparation, with  $\Phi 2\text{mm}$  head. There is water out from the tip center to avoid overheating.

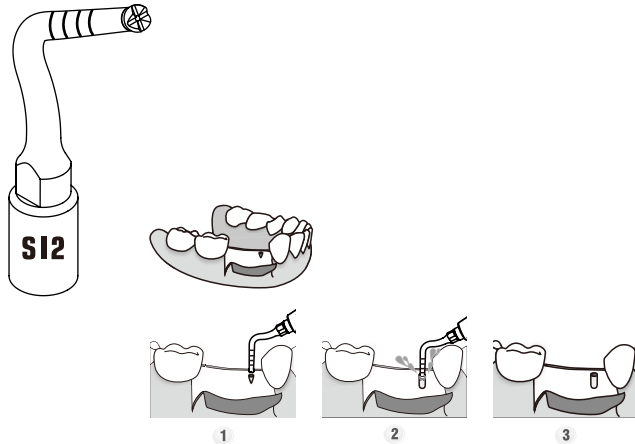

## Model: Bone

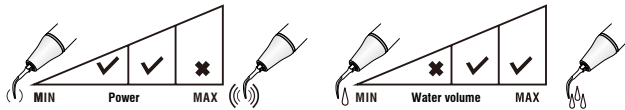

# SI3

$\Phi 2\text{mm}$  implant preparation tip used in the anterior regions, with sharp tip extremity and water out from the center.

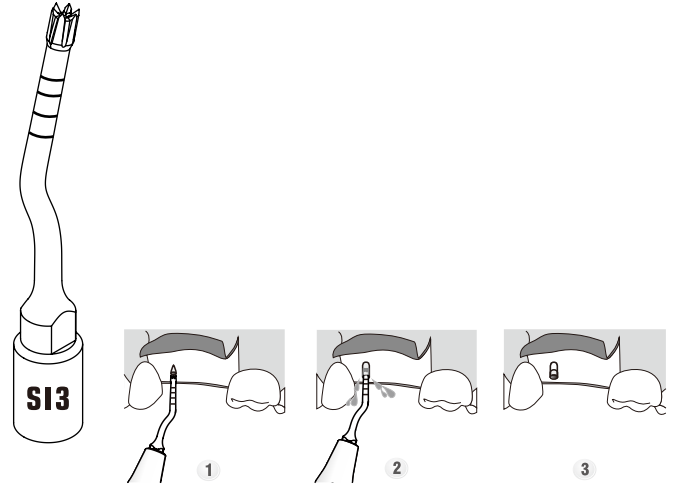

## Model: Bone



# SI4

Φ3mm implant preparation tip used in the anterior regions, with sharp tip extremity and water out from the center.

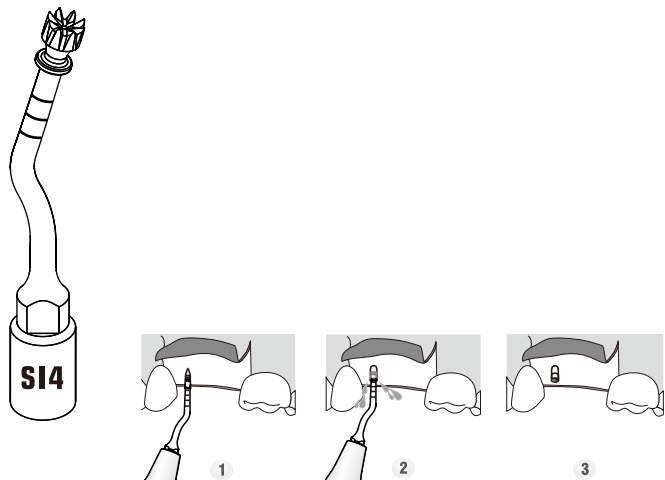

# SI5

Φ2mm implant preparation tip used in the posterior regions, with sharp tip extremity and water out from the center.

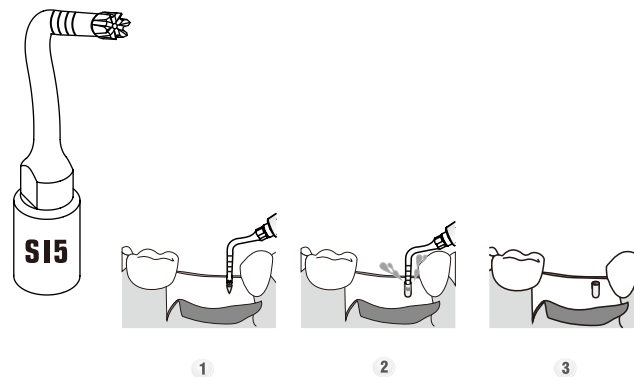

## Model: Bone



## Model: Bone



# SI6

Φ3mm implant preparation tip used in the posterior regions, with sharp tip extremity and water out from the center.

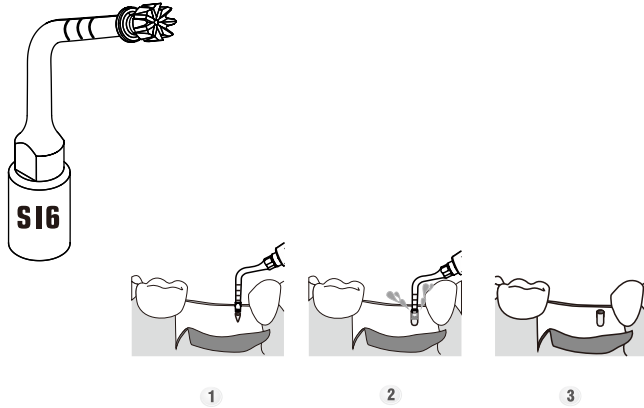

# SI7

Diamond-coated (85µm), for finalizing implant site bone preparation close to the alveolar nerve.

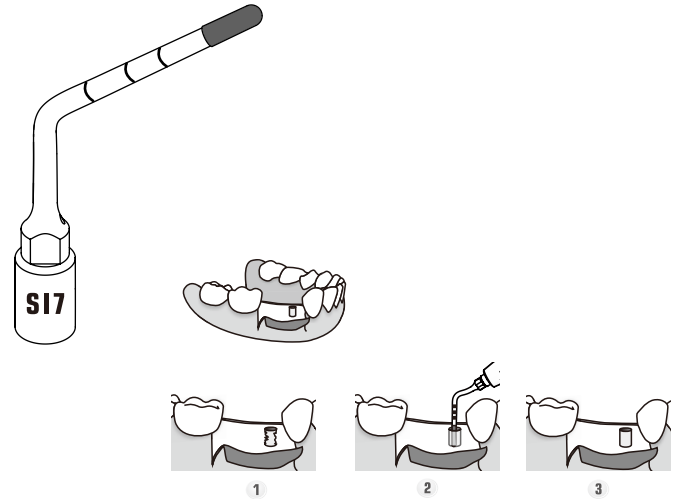

## Model: Bone

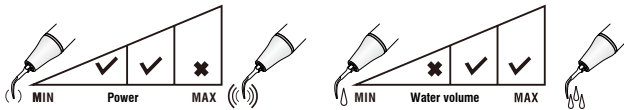

## Model: Bone



# S18

For implant preparation, with  $\Phi 1.6\text{mm}$  head and 9mm tip working length.

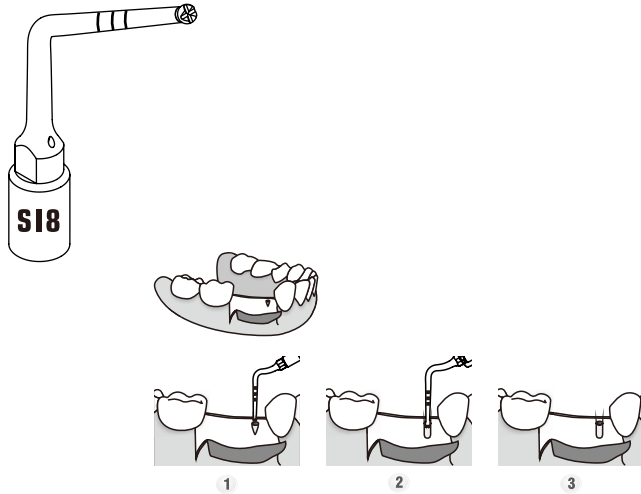

# S19

For implant preparation, with  $\Phi 2.8\text{mm}$  head. There is water out from the tip center to avoid overheating.

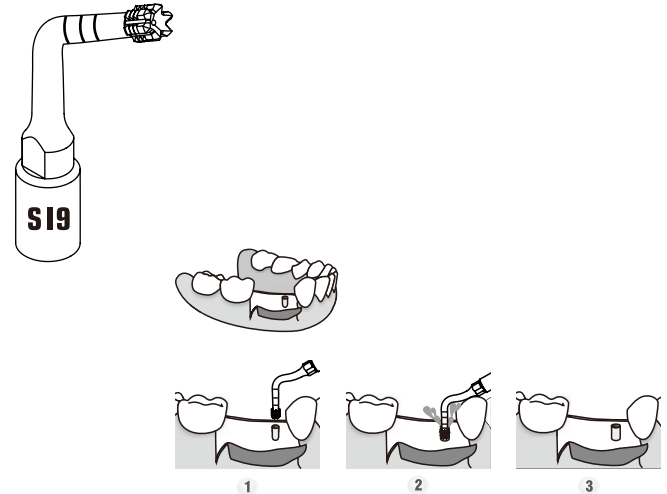

## Model: Bone



## Model: Bone



# SP1

For gentle scaling in periodontal surgery.

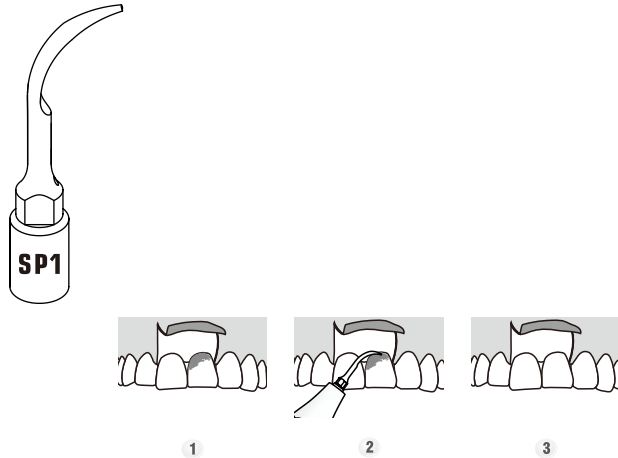

# SP2

For fractured root apex extraction and inflammatory tissue removal.

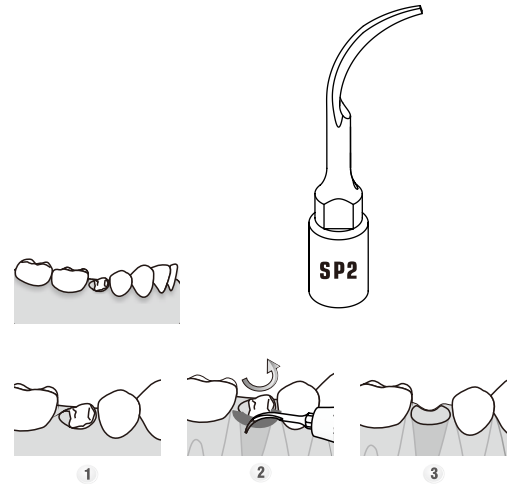

## Model: Perio

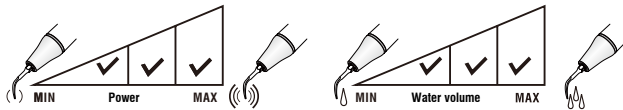

## Model: Perio





# SP3

For multi-angled gentle scaling in periodontal surgery.

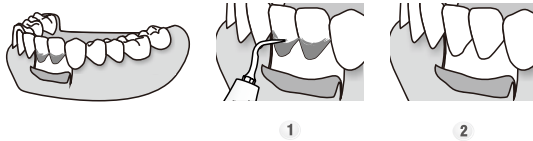
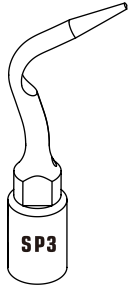

# SP4

Diamond-coated (40µm), for apical debridement and root planning.

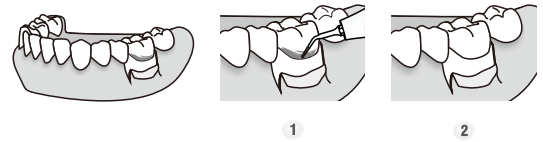
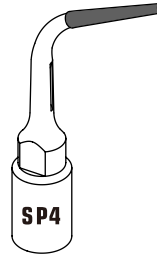

## Model: Perio

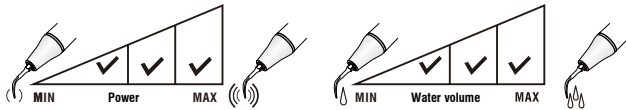

## Model: Perio



# SP5

For fine root planning.

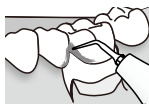
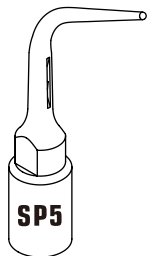

1

2

## Model: Perio

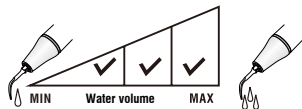
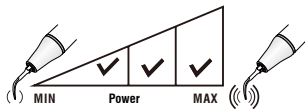

# SP6

Diamond-coated (40µm) tip for fine osteoplasty: interproximal osteoplasty and root planning.

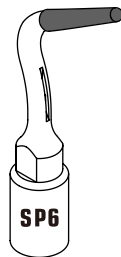

1

2

## Model: Perio

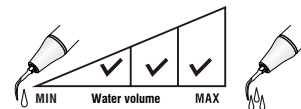
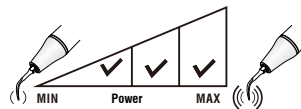

# SP7

Diamond-coated (40µm), for root canal locating and removal of calcifications in the coronal 1/3 part of root canal, and can also be used for fine osteoplasty.

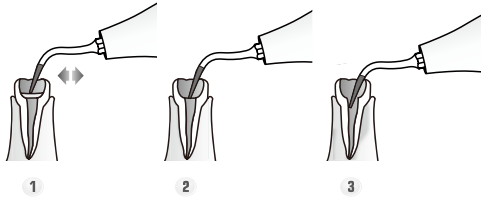
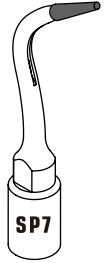

## Model: Perio



# SP8

Coarse mesh-shaped concave-convex surfaces on both sides of the head, for osteoplasty and bone trimming.

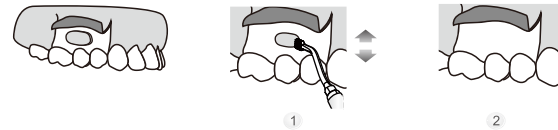

## Model: Perio

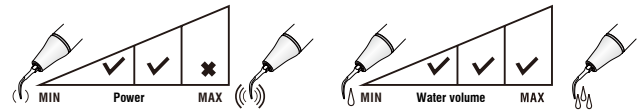

# SP9

Coarse mesh-shaped concave-convex surfaces on both sides of the head, for osteoplasty and bone trimming.

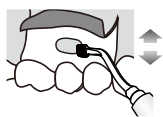

1

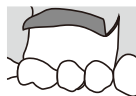

2

## Model: Perio

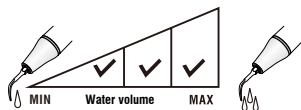
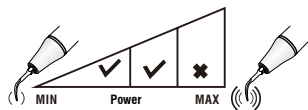



Guilin Woodpecker Medical Instrument Co., Ltd.  
Information Industrial Park, Guilin National High-Tech  
Zone, Guilin, Guangxi, 541004 P. R. China

Tel:

Europe Sales Dept.: +86-773-5873196

North/South America & Oceania Sales Dep.: +86-773-5873198

Asia & Africa Sales Dep.: +86-773-5855350 Fax: +86-773-5822450

E-mail: woodpecker@glwoodpecker.com, sales@glwoodpecker.com

Website: <http://www.glwoodpecker.com>



MedNet EC-Rep GmbH  
Borkstrasse 10 · 48163 Muenster · Germany

ZMN-XC-092 V1.0-20220719

